



www.tulon.com



## USER MANUAL

Thank you for choosing our product. Please thoroughly go through user manual before operation and keep it well for future reference. All photos here are for reference only, and specifications are subject to the physical product.

感谢您购买本产品，请在使用前阅读此说明书，阅读后请小心收藏，以备日后查阅。图片仅供参考，产品以实物为准。

## Precautions

**Always observe the following precautions:**

**When operating the device, keep it stable if possible to avoid violent shaking.**

- Do not use or store the instrument at a place with the operating or storage temperature beyond the allowable range.
- Do not align the device directly with high-intensity thermal radiation sources, such as the sun, a laser and a spot-welder.
- Do not expose the device to the dusty or humid environment.

When using the device in an environment with water, do not splash water on it. When the device is not in service, cover the lens cap.

- When the device is not in service, put it and its accessories in the dedicated packing box.
- Do not block the holes on the device.
- Do not beat, throw or shake the instrument and its accessories to ensure intactness.
- Do not disassemble the device by yourself. Otherwise, you may damage the device and void your warranty.
- Do not use the accompanying SD card for other purposes.
- Do not use the device at a place with the operating temperature beyond the specified value. Otherwise, the device may be damaged.
- Do not use deliquescent or equivalent liquid for the device and cables. Otherwise, the device may be damaged.
- After the eyepiece is used for long time, its contrast will be lowered, and the scene will be whitened. You can switch to the LCD display, and switch back to the eyepiece some time later.

**This device is powered by a rechargeable lithium battery. To use the battery safely, observe the following items:**

- Do not attempt to open or disassemble the battery in any event.
- Do not put the battery in a high-temperature environment or close to a high-temperature object.
- Do not short-circuit the battery.
- Do not put the battery in a humid environment or in water.
- If the battery leaks and some leaked liquid gets into eyes, flush the eyes with clean water immediately, and go for medical care.

• Charge the battery as specified in this manual, and follow the charging steps and precautions. Otherwise, the battery may be heated or damaged, or cause personal injuries.

**When wiping the device, take the following measures:**

- Non-optical surfaces: Wipe the non-optical surfaces of the thermal imager with a piece of clean and soft cloth when necessary.
- Optical surfaces: When using the thermal imager, do not dirty the optical surfaces of a lens. Especially, do not touch the lens with your hands. Otherwise, the sweat on hands will generate marks on the lens, and may even corrode the optical coating on the glass surface. When the surfaces of the optical lens are contaminated, wipe them carefully with dedicated lens paper.

www.tulon.ru

## Contents

<b>CHAPTER 1</b>	<b>LIST OF ITEMS.....</b>	<b>2</b>
<b>CHAPTER 2</b>	<b>PRODUCT COMPONENTS.....</b>	<b>6</b>
<b>CHAPTER 3</b>	<b>AREAS OF THE IMAGER.....</b>	<b>10</b>
<b>CHAPTER 4</b>	<b>OBSERVATION.....</b>	<b>16</b>
<b>CHAPTER 5</b>	<b>PHOTOGRAPHING.....</b>	<b>20</b>
	PHOTOGRAPHING.....	20
	AUTOMATIC PHOTOGRAPHING.....	21
	ADD NOTES.....	22
	RECORD VIDEOS.....	24
<b>CHAPTER 6</b>	<b>ANALYSIS.....</b>	<b>28</b>
	<b>REAL-TIME ANALYSIS.....</b>	<b>28</b>
	Analysis object addition/deletion.....	28
	Analysis object size change.....	28
	Palette switch.....	29
	Manual brightness/contrast adjustment.....	31
	Temperature difference analysis.....	31
	<b>FILE BROWSING.....</b>	<b>32</b>
	<b>PHOTO ANALYSIS.....</b>	<b>33</b>

## Contents

Edit a photo.....	33
Zoom in and out an image.....	34
Create a PDF file.....	35
Print a PDF file.....	36
Replay a video.....	37
<b>ISOTHERM.....</b>	<b>38</b>
Downward isotherm.....	38
Upward isotherm.....	38
In-range isotherm.....	38
Out-range isotherm.....	39
<b>EMISSION CUSTOMIZATION.....</b>	<b>40</b>
<b>CHAPTER 7 GLOBAL SETTING.....</b>	<b>42</b>
<b>SYSTEM SETTING.....</b>	<b>42</b>
Temperature measurement range.....	42
Temperature unit switchover.....	42
Distance unit switchover.....	42
Warning setting.....	43
Brightness.....	44
Timed shutdown.....	44
Timed Hibernation.....	44
Sound volume.....	45
Flashlight.....	45

## Contents

Extension lens.....	45
Custom key.....	46
Full figure of temperature tagging.....	46
Color of isotherm.....	46
Photographing setting.....	47
<b>LOCAL SETTING.....</b>	<b>48</b>
<b>CONNECTION SETTING.....</b>	<b>49</b>
<b>ABOUT UPDATE.....</b>	<b>53</b>

## CHAPTER 8 CONNECTING WITH PERIPHERAL DEVICES..... 56

<b>DIAGRAM OF PORT CONNECTION.....</b>	<b>56</b>
<b>MEMORY CARD AND LENS INSTALLATION.....</b>	<b>59</b>
<b>OUTER JOINS.....</b>	<b>62</b>

## CHAPTER 9 TROUBLESHOOTING GUIDELINE..... 64

www.tulon.ru

## Chapter 1

### List of Items

---

**Standard parts:**

Thermal imager, Lithium battery, Adapter, Adapter plug (5 pcs), SD card (16 GB), Shoulder harness, USB cable, HDMI cable, Network cable, Quick operation guide, User manual, Desktop charger (depending on the product model), CD-ROM, Carrying bag, Parts list

**Optional parts:**

Bluetooth headset, HDMI-to-analog video converter

## List of Items

### Standard parts:



Thermal imager



Lithium battery



Adapter



Adapter plug  
(5 pcs)



SD card (16G)



Shoulder harness



USB cable



HDMI cable



Network cable

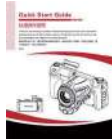

Quick operation  
guide



User manual



CD-ROM



Carrying bag



Parts list

## List of Items

### Optional parts:



Bluetooth headset



HDMI-to-analog video converter



The tele lens



The wide angle lens



The High temp Filter



Desktop charger  
(depending on the  
product model)

# www.tulon.ru

## Chapter 2

### Product Components

---

## Product Components

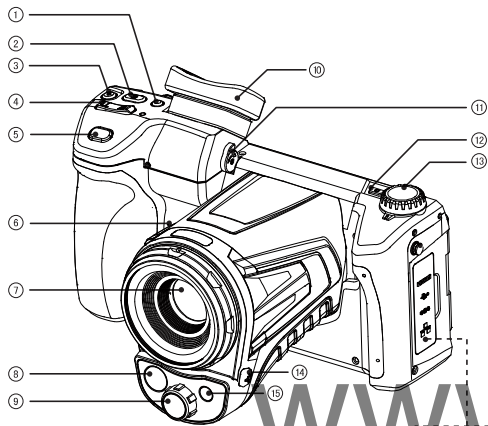

- 1 LCD/Viewfinder
- 2 Customize
- 3 Video record
- 4 Focusing
- 5 Photo
- 6 Speaker
- 7 IR lens
- 8 Illuminator
- 9 Visual light
- 10 Viewfinder

- 11 Diopter regulator
- 12 Power on / off
- 13 Mode dial
- 14 Laser button
- 15 Laser indicator
- 16 HDMI mini
- 17 Micro USB
- 18 AC adapter
- 19 RJ45

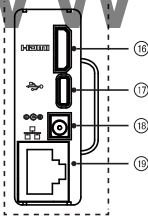

## Product Components

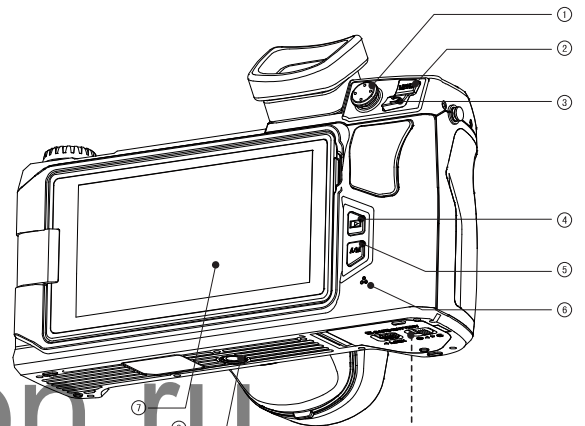

- 1 Joystick
- 2 Menu
- 3 Return
- 4 Replay
- 5 Auto / Manual (Brightness, Contrast Change)
- 6 Microphone
- 7 Tripod Connection
- 8 SD card Socket
- 9 Battery Housing

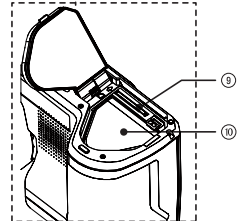



# www.tulon.ru

## Chapter 3

### Areas of the Imager

---

**Introduction to each area**  
**Main replay screen**  
**Short-cut menu**

## Areas of the Imager

### A Introduction to each area

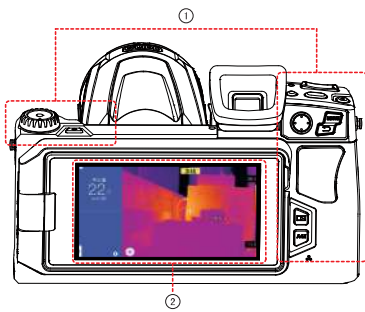

- 1 Control Area
- 2 Display Area

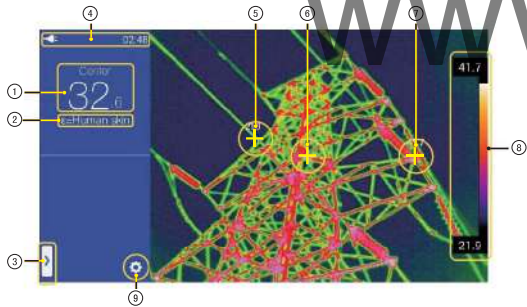

- |                      |                 |          |
|----------------------|-----------------|----------|
| 1 Center temperature | 4 Status        | 7 Tmax   |
| 2 Emissivity         | 5 Tmin          | 8 Pallet |
| 3 Menu               | 6 Center curcor | 9 Setup  |

## Areas of the Imager

### B Main replay screen

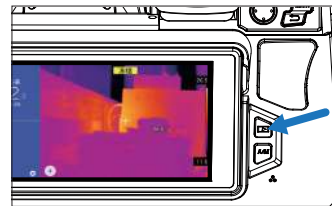

1. Press the "Replay" button on the imager.

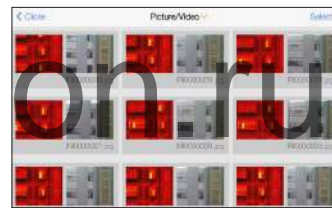

2. Change to the photo browsing screen directly.

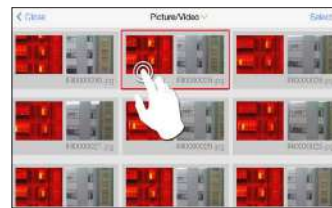

3. Touch to click any photo.

## Areas of the Imager

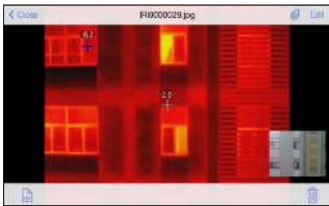

4. View the image information.



5. Click the "Edit" button in the upper right corner or the "Parameter" button to display an area for editing the analysis object.



6. Modify the temperature measurement image. Before you exit from the screen, a dialog box is displayed, showing "Are you sure to save the modification?" Click the "OK" button to save the modification, and exit from the screen.

## Areas of the Imager

### C Short-cut menu

This screen mainly involve short-cut operations which can be performed in real-time scenes, including image analysis, thermometric analysis, parameter modification, quick start of wireless AP and LAN, automatic photographing, and automatic recording.

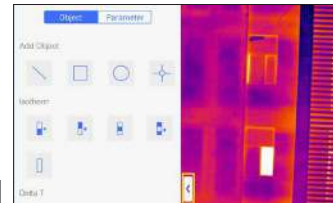

#### Navigating to the short-cut menu

- In the real-time scene state, press the physical button "MENU" on the imager, or click the ">" button in the lower-left corner of the touch screen to display the short-cut menu screen.

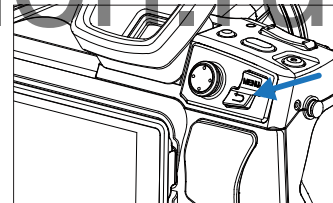

#### Return button

- Press the "Return" button or click the "<" button to exit from the short-cut menu and return to the real-time screen.

www.tulon.ru

## Chapter 4

### Observation

Switching the eyepiece  
Switching the image mode  
Temperature measurement  
Manual/automatic focusing  
Electronic zooming

## Observation

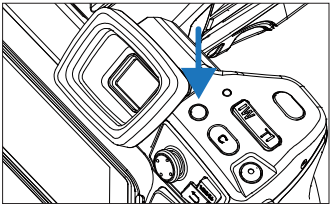

("Switch LCD/eyepiece" button)

### Switching the eyepiece

- After power-on, the LCD display shows the main screen by default. Press the "Switch LCD/eyepiece" button to disable the LCD display and enable the eyepiece immediately. Press the "Switch LCD/eyepiece" button again to enable the LCD display and disable the eyepiece.

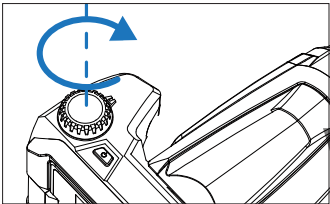

### Switching the image mode

- Rotate the mode dial in the upper-left part of the imager to switch the image mode among the following four modes:



### A. Picture-in-picture

- Switch to the PIP identification mode.

## Observation

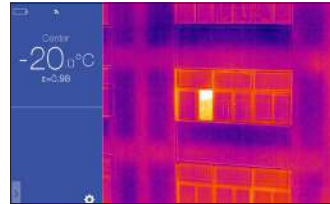

### B. MIF

- Switch to the MIF identification mode.

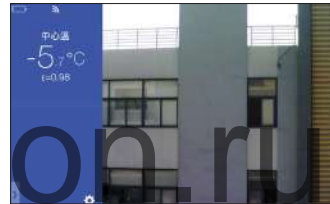

### C. Visible light

- Switch to the VL identification mode.

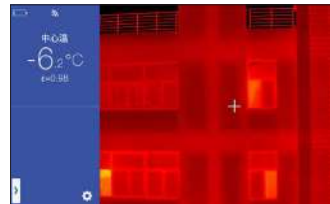

### D. IR

- Switch to the IR identification mode.

## Observation

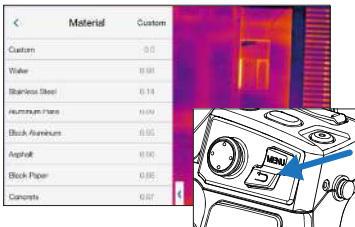

### Temperature measurement

- In the real-time image state, choose "Shortcut menu" → "Parameter" → "Materials setting" to select the emissivity for the target. Press the "Return" button or click the "◀" button to return to the real-time screen, and then align the center point cursor with the target to measure the temperature.

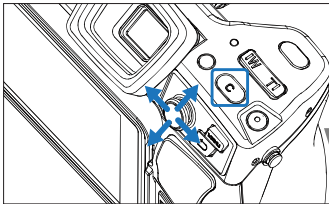

### Manual/automatic focusing

- Press the "Up"/"Down" button to conduct far/close focusing adjustment.
- Set the function of customization button "C" to automatic focusing ("System setting" → "Button customization" → "Automatic focusing"). For details, see the section "Button customization". Align with the target, and press the customization button "C". A few seconds later, conduct automatic focusing until completion.

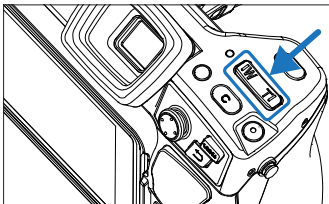

### Electronic zooming

- Press the physical buttons "W" (zoom in) and "T" (zoom out) on the imager to conduct digital zooming operations.

## Chapter 5

## Photographing

**Photographing**  
**Automatic photographing**  
**Add notes**  
**Record videos**

## Photographing

In the real-time scene state, press the "Photographing" button on the imager to freeze a scene, take a photo, and save it in the current scenario. Choose "System setting"→"Photographing setting", and then directly set the function of the photographing button to photographing for one-click photographing.

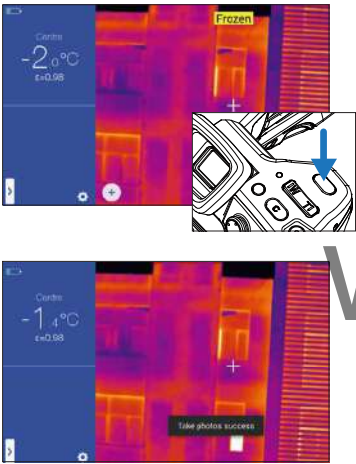

1. Press the "Photographing" button on the imager once to freeze a scene, as shown in the figure below.

2. When the scene is frozen, press the "Photographing" button again to save the frozen image automatically.

## Automatic photographing



### Setting automatic photographing

- In the real-time image state, choose "MENU"→"Automatic photographing", and navigate to the time fixed photographing button. Click the rear-right area to display the screen for setting automatic photographing parameters.

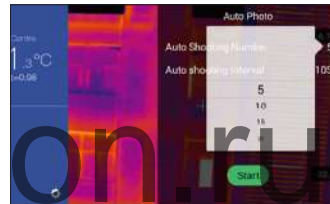

### Setting the number for automatic photographing

- Click the number for automatic photographing option to select a specific number.
- Click the "Start" button to boot the time fixed photographing program based on the preset number for time fixed photographing.

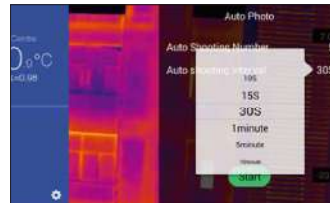

### Setting the interval for automatic photographing

- Click the interval for automatic photographing option to select an appropriate interval.
- Click the "Start" button to boot the time fixed photographing program based on the preset time interval.

💡 This function is available for partial models only

## Add notes

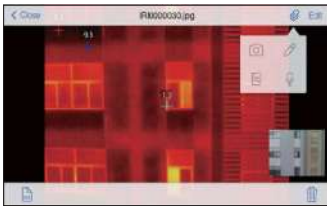

### Add notes

1. Press the "Replay" button on the image to display the directory for browsing files.
2. On the touch screen, click and choose the original image to be added with notes, and preview it.
3. Navigate to the single image browsing screen, and then click the attachment icon in the upper-right part to display the short-cut menu for add notes.



### Add photographing notes

1. Click the photographing notes addition button to display the main screen for photographing notes.
2. Click the photographing button to take at most two visible light photos, as shown in the figure below.



### Add text notes

1. Click the text notes addition button.
2. Change to the area for inputting text notes, and then input effective notes, such as XXXX.
3. Click the checkmark button in the upper-right corner to save the text notes.

## Add notes



### Add voice notes

1. Click the voice notes addition button to display the voice notes screen.
2. Click the recording button to start recording.
3. Click the Stop button to stop recording and save the record file. The system can make a record for 60s at most, as shown in the figure below.

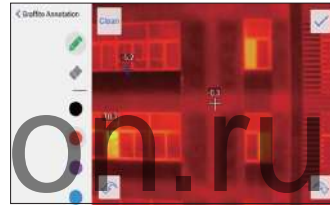

### Add graffiti notes

1. Click the graffiti notes addition button to display the graffiti screen.
2. The left buttons are paintbrush, eraser and color selection buttons successively. You can choose any function before conducting graffiti operations in the image areas directly.
3. The four functional buttons in the right scene are "Clear", "Save", "Cancel" the previous operation" and "Recover" buttons respectively from left to right. You can conduct operations to the image areas by pressing these buttons.
4. Click the checkmark button to save the graffiti data. Click the "Clear" button to clear the current graffiti operation. Click the button to restore the previous graffiti operation. Click the button to recover operation.



## Record videos

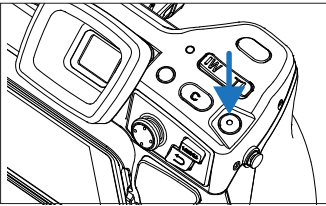

### One click recording

- In the real-time image screen, focus on the target. (Before shooting a clip, conduct automatic focusing or manual focusing.)
- Press the "Record" short-cut button on the imager.

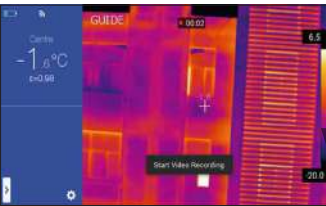

### Start recording

- The record timing information begins to be displayed in the upper-right corner.

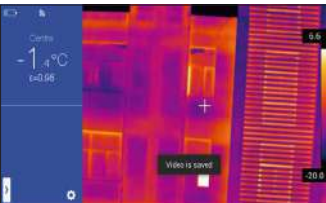

### Stop recording

- Press the "Record" button again to end recording and save the video data. (To view the recorded clip, press the "Replay" short-cut button to skip to the replay screen.)

## Record videos

### Setting the time fixed video recording (provided for some models only)

In the real-time image state, press the "Menu" → "Automatic photographing" buttons successively to find the time fixed video recording button.

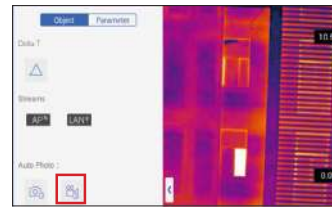

### Setting video recording

- Click the time fixed video recording button to record videos automatically according to the preset video recording interval, with the recorded videos in mp4. You can view the saved videos in the photo browsing screen. At the same time, you can also press the physical buttons on the imager to record videos. See the figure below.

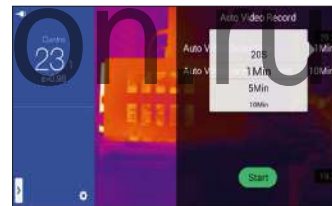

- Record delay setting**  
Choose a customized value through the scroll box.

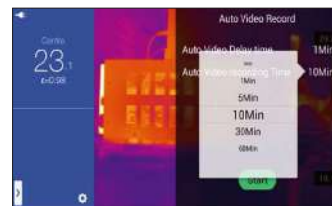

- Setting record duration**  
• Choose an appropriate value through the scroll box.

## Record videos

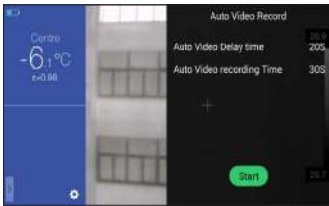

### Starting time fixed video recording

- Click the Start button in the lower part.

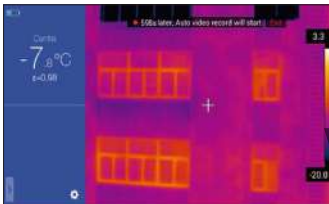

### Stopping video recording and photographing

- Click the "Exit" button in the upper-right part of the screen to stop recording.

## Chapter 6

### Analysis

- Real-time analysis
- File browsing
- Photo analysis
- Isotherm
- Emissivity customization

www.tulon.ru

## Real-time analysis

### Analysis object addition/deletion



1. Click the  icon in the lower left corner to enter the analysis object addition menu screen in the real-time scene as shown in the photo below.

• Multiple analysis objects are provided, such as line, rectangle, circle and point. At the same time, maximum temperature, minimum temperature and average temperature displays as well as display in the middle can also be customized as shown in the photo below.

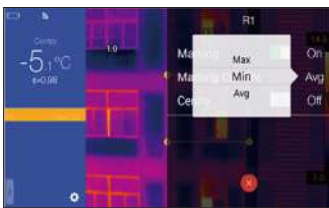

2. Hold any analysis object on the touch screen, and then the system will pop up an object menu automatically, with its functions shown below.

• Marking: Control the temperature markings (maximum temperature, minimum temperature and average temperature) to be displayed.

• Marked temperatures: Display the maximum temperature, minimum temperature and average temperature in the analysis object areas.

• Middle: Control whether to display the analysis object in the middle.

Deletion button: Touch to press the  button in the edition screen to delete the current analysis object.

### Analysis object size change

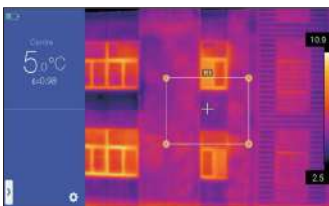

1. Choose any one analysis object and mark it with  if all its nodes are chosen and yellow.

2. Move any one node to change the range of the analysis object.

## Real-time analysis

### Palette switch

1. Enter the main screen to click the right palette area in the screen, and then the system will pop up some palette options, including Candescent, Lava, Brilliance, Rainbow, North pole, Hot Iron, Stratification, Medical, Red Trace and Black Heat. (Less palette options provided for some models)

2. The user can switch various color band models freely as shown in the photo below:

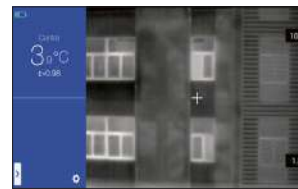

Candescent



Lava



Brilliance

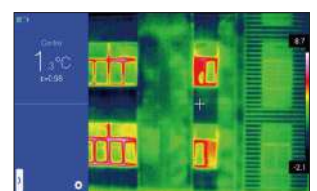

Rainbow

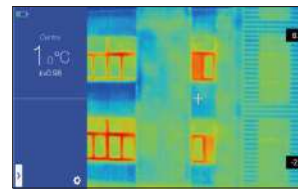

North pole

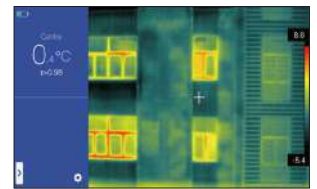

Hot Iron

## Real-time analysis

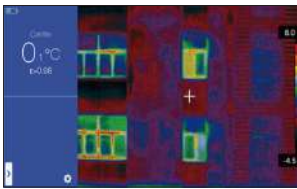

Stratification

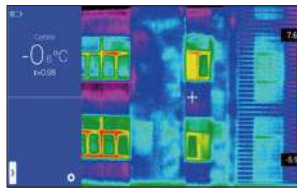

Medical

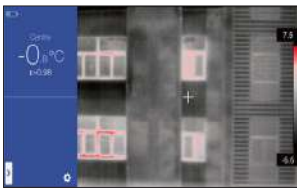

Red Trace



Black Heat

## Real-time analysis

### Manual brightness/contrast adjustment

1. Press the Menu button to open the menu option in the real-time scene state.
2. Press the lock button  in the lower right part of the imager gently to lock both maximum and minimum color band temperature values in the real-time video scene.
3. Click the maximum or minimum temperature to pop up the corresponding value menu in the system automatically as shown in the photo below (Lock the temperature).
4. Choose an appropriate high or low temperature value first, and then click any area in the scene to save the temperature value and redisplay the new result.



Lock the temperature

### Temperature difference analysis

1. Add at least 2 analysis objects first, and then click the temperature difference button under the object tag to activate the temperature difference mode.
2. Temperature difference analysis: Choose at least 2 analysis objects for temperature difference analysis, and then relevant data will be displayed in the left data field automatically.
3. Exit the temperature difference analysis mode: Enter the short-cut menu-temperature difference function and click the activated temperature difference icon  again to exit the temperature difference state.

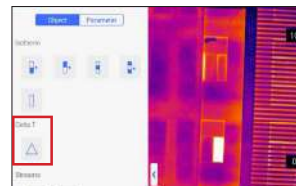

Prior to temperature difference analysis

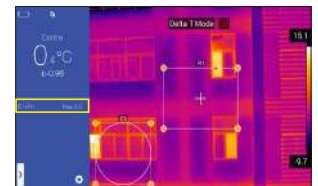

After temperature difference analysis

## File browsing

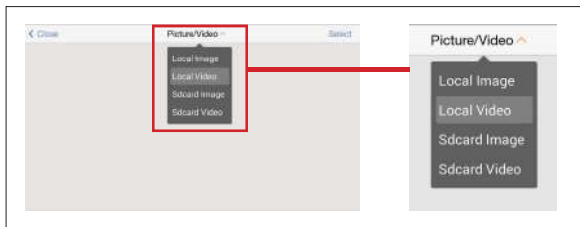

1. Local photos. Press the "Replay" button to enter the main file browsing screen, and then click "Photos"—"Local photos" successively to display all the locally stored photos in the system automatically.
2. Local videos. Press the "Replay" button to enter the main file browsing screen, and then click "Photos" – "Local videos" successively to display all the locally stored videos in the system automatically.
3. Photos stored on the SD card. Press the "Replay" button to enter the main file browsing screen, and then click "Photos" – "Photos stored on the SD card" successively to display all the photos stored on the external SD card in the system automatically.
4. Videos stored on the SD card. Press the "Replay" button to enter the main file browsing screen, and then "Photos"—"Videos stored on the SD card" successively to display all the videos stored on the SD card of the user in the system automatically.

## Photo analysis

### Edit a photo

1. Click any photo in the photo preview screen to enter the photo edition screen.
2. Click the  button to pop up a notes menu in the system automatically, and then add voice notes, text notes, etc. to the current photo.
3. Click the "Edit" button to conduct analysis object addition and modification, isotherm modification and temperature difference modification to the current photo.



Edit the analysis object

4. Click the "Parameter" button to modify other attributes and save the settings after exit as shown in the photo below.



Image attributes

## Photo analysis

### Zoom in and out an image

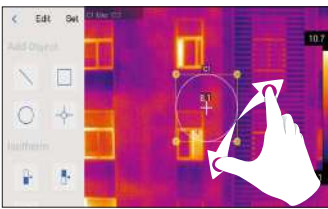

- Touch the screen with two fingers in the photo edition mode, and then spread on the screen.
- Spread to zoom in an image by up to 10 times.



- Pinch to zoom out an image.

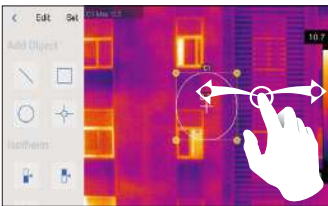

- Slide a single finger on the touch screen to move and zoom in an image.

## Photo analysis

### Create a PDF file

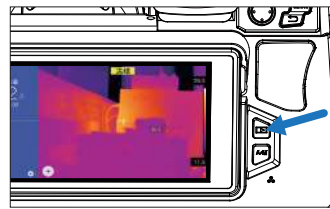

1. Press the "Replay" button to enter the photo browsing screen.

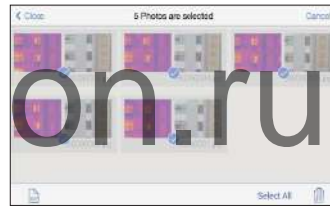

2. Click the "Choose" button to choose at most 5 images freely as shown in the photo below.



3. Click the "PDF" button in the lower left corner to generate a PDF preview file.

## Photo analysis

### Print a PDF file

1. Connect the wireless printing network (wireless printing) on the system setting-connection setting screen.
2. Enter the replay screen, and choose an image to printout a PDF file. For more details, please see the chapter "Generate a PDF file".
3. Touch to press the "Print" button in the upper right part of the PDF preview screen.



PDF print

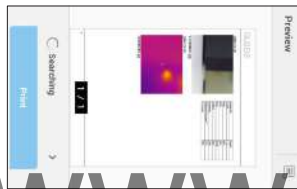

Print Preview

## Photo analysis

### Replay a video

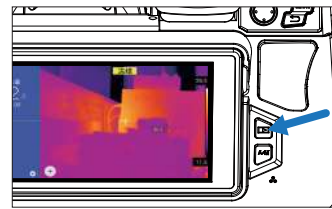

1. Enter the photo replay screen, click "Photos" "Local videos" to enter the local video screen successively and then choose a video clip in MP4.



2. Replay the clip
  - Click the "Play" button in the middle of the screen to play the clip.
  - Click the screen to display the clip replay panel.
  - Click the "Pause" button at the bottom of the screen to pause, the clip while the short video is played.

## Isotherm

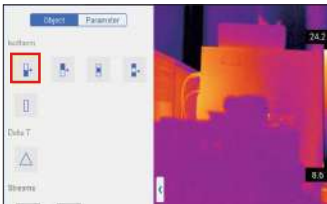

### Downward isotherm

1. Call out the main menu with the physical Menu, and then slide the object screen down to the isotherm column with a single finger.
2. Touch to click the  icon in the isotherm column, and then the target scene is in the downward isotherm image mode as shown in the photo below.

## Isotherm

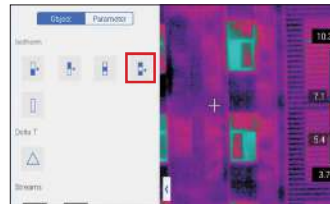

### Out-range isotherm

1. Call out the main menu with the physical Menu.
2. Click the  icon to enter the out-range isotherm image mode as shown in the photo below.



### Upward isotherm

1. Call out the main menu with the physical Menu.
2. Click the  icon to enter the upward isotherm real-time video image mode as shown in the photo below.



### Cancel the isotherm

- Click the  icon in the analysis object menu option to close the isotherm display as shown in the photo below.

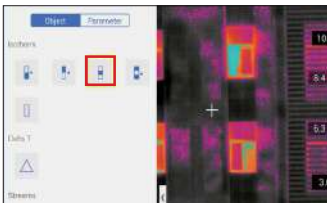

### In-range isotherm

1. Call out the main menu with the physical Menu.
2. Click the  icon to enter the inrange isotherm image mode as shown in the photo below.



## Emissivity customization

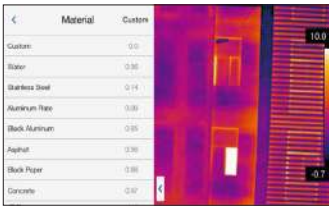

1. Click it to enter the menu-parameter screen, and then choose the "Materials" option where multiple presetting items are provided at present as shown in the photo below.

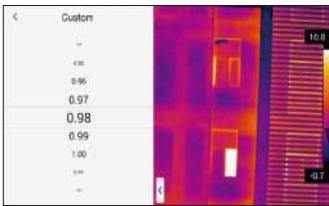

2. Customize parameters as required within 0.01–1.00 by sliding the corresponding values, and then click the "C" button in the upper left corner to exit it and save the modification as shown in the photo below.



### Introduction to the parameters to be customized:

Reflected temperature: The user can modify the parameter as required within 0–100.

Target distance: The user can modify the parameter as required within 0–100.

RH: The user can modify the parameter as required within 0–100%

## Chapter 7 Global Setting

System Setting  
Local Setting  
Connection Setting  
About Update

## System Setting

On the real-time video screen, click . Then enter into the global setting screen, in which alter the main parameters for system, including unit of temperature and distance, brightness, network connection, data & language and E-mail configuration.

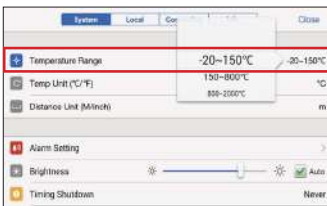

### Temperature measurement range

- Set thermometry range for measured targets. (provided for some models only)



### Temperature unit switchover

- Switch unit between Centigrade °C and Fahrenheit °F. (Centigrade °C by default °F)

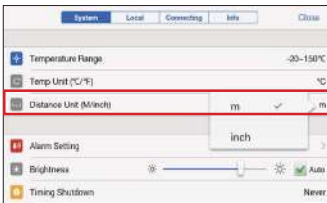

### Distance unit switchover

- Switch between Meter and Foot. (Meter by default)

## System Setting

### Warning setting

Manage the temperature and range for warning (Inactive state by default). Obtain warning temperature range in Temperature Measurement Range. The warning temperature range is Low/High.

Warning temperature is in the scope that temperature measurement range is -20~150°C.



### High temperature warning

1. Open temperature warning switch, set the warning temperature range as "High" (setting value: -20°C).
2. Return to the real-time temperature measurement screen, and the machine will immediately give an alarm by sound.
3. Click to close the sound, as follows:

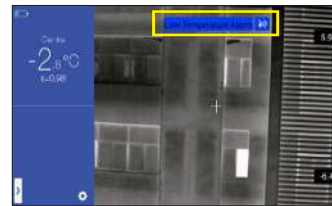

### Low temperature warning

1. Start temperature warning switch, set the warning temperature range as "Low" (setting value: 30°C)
2. Return to the real-time temperature measurement screen, and the machine will immediately give an alarm by sound.
3. Click to close the sound, as follows:

## System Setting

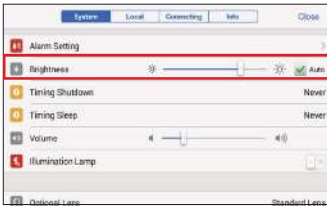

### Brightness

- Adjust brightness for touch screen automatically or manually.

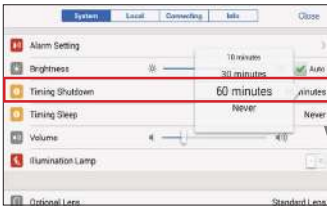

### Timed shutdown

- Set "Timed shutdown" (Never by default). Five choices: 5 Minutes, 10 Minutes, 30 Minutes, 60 Minutes and Never.

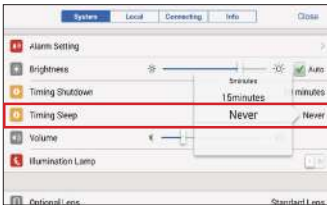

### Timed Hibernation

- Set "Timed Hibernation" (Never by default). Four choices: 1 Minute, 5 Minutes, 15 Minutes and Never.

## System Setting

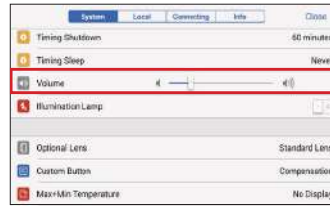

### Sound volume

- Regulate sound volume or mute.



### Flashlight

- Turn on/off flashlight (Off by default).



### Extension lens

- Set the extension lens manually (Normal lens by default).

## System Setting

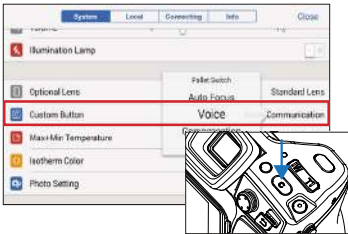

### Custom key

- Set imager's user-defined shortcut for operation, including flashlight, palette bring-up, auto-focusing and compensation.

## System Setting

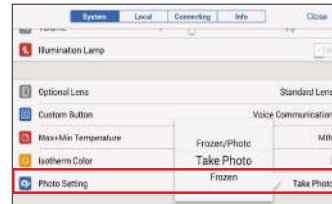

### Photographing setting

- Set camera button to operate, including Freeze/Photographing, Photographing and Freeze.

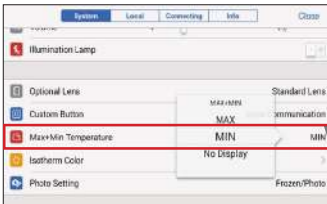

### Full figure of temperature tagging

- Manage High/Low temperature tracking mode in real-time screen. The default is not to display (shut down the tracking).



### Color of isotherm

- Customize the color for high, low and in-range isotherm.

www.tulon.ru

## Local Setting

### Report setting

- Modify all parameters for PDF report, including its logo, header, footer and model selection (provided for 3 preset models)



Report setting

### Time/date

- Set the time and date for system manually.

### Language

- More than one language choices.

### Watermark

1. Turn on part watermark selections in the watermark setting: Logo, Date, Emis-sivity, GPS, Location, etc.
2. Return to the real-time scene and take a sample photo.
3. Press replay short-cut, enter into picture browsing screen and preview the sample photo.
4. All enabled watermark information will display at the bottom of preview file.



Watermark

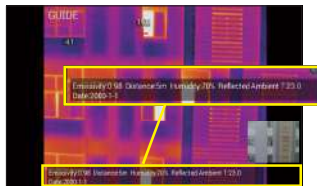

Preview of watermark

## Connection Setting

### WIFI

-  on the top of main screen means that the device has connected to WLAN. (Enable/disable WIFI module functions)



1. Select network: click a listed one and input passwords if needed.

Access the enclosed WLAN: click "Others" and input the name of enclosed WLAN. Network name, safety type and passwords are all indispensable.



2. Enter into connection screen after proper passwords input.



3. Click  (More Information button), enter into the WIFI address setting screen, in which the User can select STATIC tag and modify IP address.

Ignore network: click  (More Information button) next to the connected network and choose "Ignore Wireless Network".

## Connection Setting

### Device IP setting

The User enables to customize address for IP and DNS server.

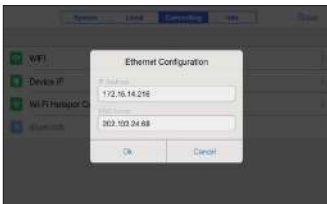

1. IP address: input effective IP address, such as 172.16.14.216 and DNS server address 202.103.24.68 (the User defines them based on own LAN status)



2. Host IP setting: set local IP address as "172.16.14.230" and DNS as "202.103.24.68" for desktop, then use it with accompanying software\*.

**\*Need to be used with PC application software.**

## Connection Setting

### WIFI hotspot configuration and connection with APP

1. Enter into Global Menu– Connection Setting–WIFI Hotspot Configuration Tag.
2. On the configuration screen, input effective hotspot name "Camera", passwords "12345678", and click "OK" to save.



WIFI Hotspot configure

3. Return to main screen of real-time scene, touch to press > (short-cut menu button) at the left bottom, select and enable AP.
4. With AP enabled, Activated State will be displayed in taskbar of main screen.
5. After enabling AP function, the User may input proper SSID and Passwords in mobile APP to connect with WIFI (**SSID=Camera, passwords=12345678**)
6. Connect with APP: open and connect with WIFI hotspot in Android/Iphone mobiles, and input above SSID and passwords for a success connection.
7. Run the App: APP will be connected and display real-time scene.

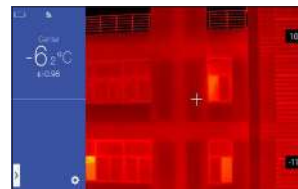

AP connection is successful

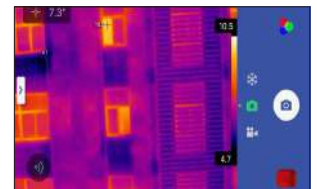

APP connection is successful

Notice: after every click for short-cut of Global Menu, AP will close automatically. The User needs to open it again in the main menu screen of real-time scene.

## Connection Setting

### Bluetooth headset pairing

1. Enable Bluetooth headset, press talk-listen button for 3 seconds to turn on pairing mode. (The blue indicator light will be on and last for 3 minutes.)
2. Enter into System Setting-Connection Setting-Bluetooth headset: system will search Bluetooth devices automatically with Bluetooth setting enabled. Pair with the listed Bluetooth headset HM1900.
3. Once the pairing is completed, the Headset will reconnect it after every enablement.



Open the bluetooth



Matching success

## About Update

### SD card upgrade

- Put the latest upgrade apk document into the directory of G Camera/update in external SD card. Click update button, there will have notice for normal/failure upgrade operation. After successful upgrade, the machine needs to restart.

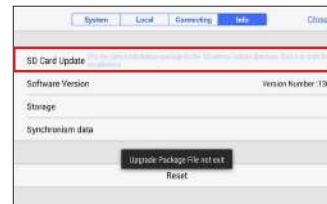

### Memory space

- It mainly indicates the left space of internal storage device and basic information of external SD card. Moreover, the User is able to set memory selection for imager internal storage and external SD card.
- Select memory medium: in the device storage screen, the User may select internal device or external SD card for data storage.

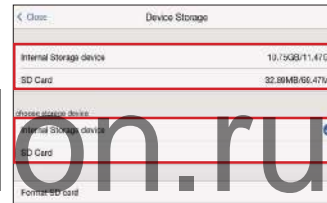

### SD card formatting

- Formatting: select a storage card slot, and choose 'Yes'.
- Notice: formatting will delete all photos and data in storage card of the selected slot permanently. Before formatting, back up data according to needs.



## About Update



### Restore default

1. Enter into Setting Menu–Information–Restore Default, and click restore setting tag.
2. The machine will be reverted to factory defaults through this. (Be careful)

## Chapter 8

www.tulon.ru Connecting With Peripheral Devices Setting

Diagram of Port Connection  
Memory Card and Lens Installation  
Outer Joins



## Diagram of Port Connection

### Diagram of Port Connection

This product may connect with peripheral devices by HDMI data line, USB data line and cable. (Illustrated)

#### Mini HDMI port

Mini HDMI port is mainly used to connect with external HD display under the precondition that the Display has HDMI port.

1. Connect HDMI cabin with thermal imager.
2. Make "HDMI" mark of Mini HDMI plug towards the front of device, and insert the plug.
3. Connect HDMI cabin with HDMI IN port of HD display.
4. Turn on HD display and switch video input to select connective port.

#### USB port

1. Check internal storage files.

Connecting USB data line with desktop, open "My Computer" to check internal memory disc, enter into "Internal Memory Device", find the pictures storage folder (Specific path: \SABRESD-MX6DQ\Internal Storage Device\DCIM\G Camera\Source Image).

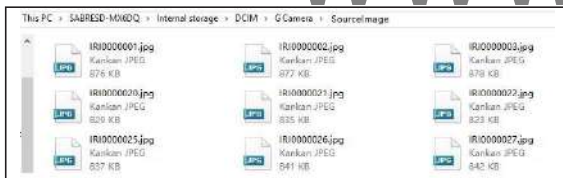

**Notice:** the folder name with "IRI": IR images; with "VIS": Visible light images.

2. Check SD card files.

Storing photos into SD card: enter into Global Setting-Information-Memory Space, and select the memory medium as SD card, then the files will be stored in SD card after next time photographing.

## Diagram of Port Connection

Connecting USB data line with desktop, open "My Computer" to check internal memory disc, enter into "Internal Memory Device" (Path: \SABRESD-MX6DQ\SD card\DCIM\G Camera\Source Image).



**Notice:** the folder name with "IRI": IR images; with "VIS": Visible light images.

#### LAN port

1. Internet access: connect the cable port of desktop with C series device' s internet access in a normal state.
2. IP setting: enter into Global Menu-Connection Setting-Device IP, the User may adjust related parameters manually. Input proper address of IP and DNS (see details in the Section of Device IP Address).
3. LAN port access: enter into main screen of real-time scene, open menu selection, click **LAN** to enable LAN connection.



(Need to be used with PC application software)

## Diagram of Port Connection

4. Connecting with application software: enable the Windows IR analysis software, enter into video analysis screen, choose model and input proper IP address.

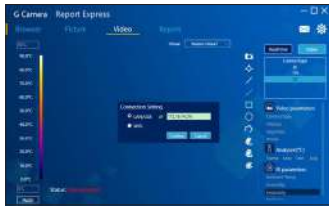

5. Real-time scene display: connect with devices, and show normal real-time scene.



💡 Open the live thermal video in the IR analysis software on PC/mobile terminal APP on by Wifi connection, if click the set button on the device, the live thermal video will disconnect. When you need use it on PC/mobile terminal APP, please connect again.◦

## Memory Card and Lens Installation

Supporting SD card: all photos and videos can be stored in local or SD card. The maximum capacity of supported SD card is 32GB, and standard configuration is 16GB. Supported SD card includes:  
( 1 ) Samsung: 16GB CLASS10, ( 2 ) SanDisk: 16GB CLASS10,  
( 3 ) Kingston: 16GB CLASS10;

• Ensure that the protective switch of memory card has been set in the above position for writing or deletion.

### Memory card installation

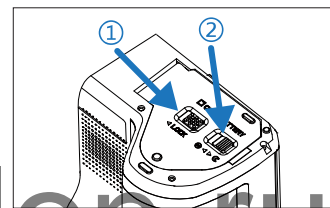

1. Open the slot cover.  
• As indicated direction by the arrows, slide and open the slot cover to insert memory card.

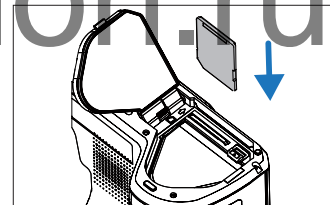

2. With label side of memory card facing you (as follows), insert it until there is a click sound.

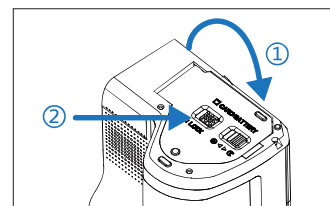

3. Close the slot cover.  
As the indicated direction by the arrows, close and slide the slot cover to lock it.

## Memory Card and Lens Installation

### Memory card remove

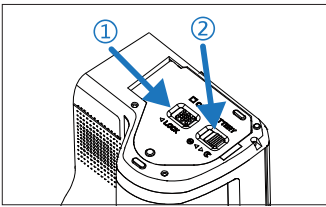

1. Close device power supply and open the slot cover.

**(Must confirm the indicator light is off before open)**

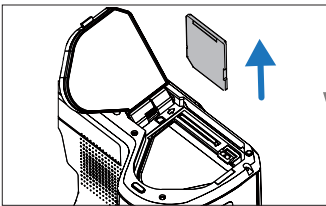

2. Memory card remove: Push the memory card slightly, then release it to exit.

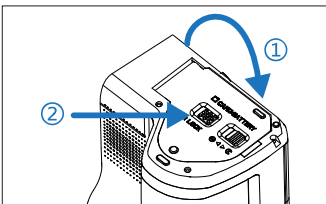

3. Take out it straightway and close slot cover.

 The number of photos is determined by the left capacity of memory card, image recording quality, etc.

## Memory Card and Lens Installation

### Matching lens installation

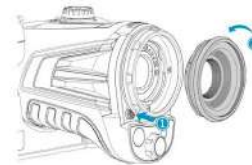

1. Press lens-changing button, remove the ring at indicated direction.

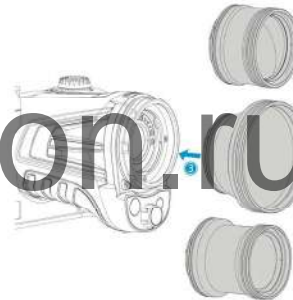

2. Turn the groove of optional lens upwards and insert into lens cone.

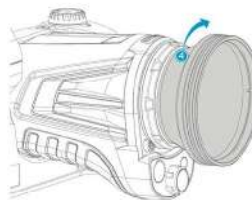

3. Rotate optional lens at indicated direction until a click sound happens.

**(Remove optional lens is in the same way as that for remove the ring)**

## Outer Joins

### Wireless AP setting

1. Enter into the object menu screen, click **AP<sup>®</sup>** to enable AP function.
2. AP function enablement will be displayed automatically in the Status bar, and it is achievable to search signals by wireless card. SSID: GCamera is a factory default name. If want to modify it, refer to the section of Connection Setting–WIFI Hotspot Configuration.
3. Click **AP<sup>®</sup>** again, then to disable this function. As follows:



AP function enablement

## Chapter 9

### Troubleshooting Guideline

#### Common problems

### Acquiring the latest IOS/Android application program

See detailed information in **Download Center** of our official website.

**IOS version:** enter into Apple Store, input the key words "Thermography" to search iPhone/iPad version,

**Android version:** adopt primary domestic application markets (360 Mobile Assistant, Pea Pod, etc.), and input key words "Thermography" to download; foreign users may download it on our official website.

## Troubleshooting Guideline

### Common problems

Fault	Reason	Solution
Unable to boot	Low battery	Battery charging
	Battery: poor contact	Take out, put it again in battery cabin and install in place.
	External power supply: not plugged in place	Pull out plug, reinsert and push it in place.
Serious deviation between battery capacity indication and actual situation	Run out of battery	Replace a fully charged one.
	Beyond the battery service life	Replace a new one.
Fogged IR image	No focusing	Adjust focusing manually or automatically to get clear images.
	Unclean lens (steam, dust, etc)	Use special device to clean.
Fogging visible light image	Dark environment	Adopt illumination measures
	Unclean visible light front-end (steam, dust, etc)	Use special device to clean
False temperature measurement	No focusing on targets	Adjust focusing manually or automatically to get clear images and read the temperature value.
	Improper setting for parameters of temperature measurement	Modify parameter setting, or directly restore the default parameter value.
	Long time no heterogeneity correction	Heterogeneity correction: Set the custom button as "Compensation" in the menu, press custom physical button and there is a shutter sound.
	Immediate temperature measurement after boot	To guarantee the temperature measurement accuracy, it would be better to wait 5–10 minutes before temperature measurement.
	Long time no calibration	To acquire precise temperature value, it would be better to send back the thermal imager for calibration once a year.